

## Reflective Optical Sensor with Transistor Output

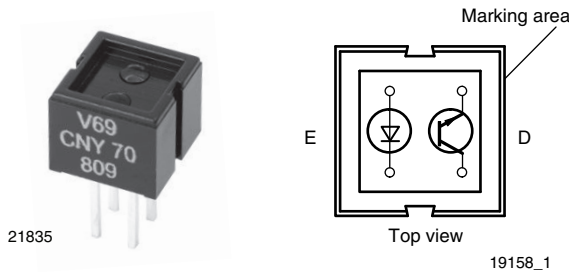

### DESCRIPTION

The CNY70 is a reflective sensor that includes an infrared emitter and phototransistor in a leaded package which blocks visible light.

### FEATURES

- Package type: leaded
- Detector type: phototransistor
- Dimensions (L x W x H in mm): 7 x 7 x 6
- Peak operating distance: < 0.5 mm
- Operating range within > 20 % relative collector current: 0 mm to 5 mm
- Typical output current under test:  $I_C = 1$  mA
- Emitter wavelength: 950 nm
- Daylight blocking filter
- Lead (Pb)-free soldering released
- Material categorization: For definitions of compliance please see [www.vishay.com/doc?99912](http://www.vishay.com/doc?99912)

**RoHS**  
COMPLIANT

### APPLICATIONS

- Optoelectronic scanning and switching devices i.e., index sensing, coded disk scanning etc. (optoelectronic encoder assemblies).

### PRODUCT SUMMARY

PART NUMBER	DISTANCE FOR MAXIMUM CTR <sub>rel</sub> <sup>(1)</sup> (mm)	DISTANCE RANGE FOR RELATIVE I <sub>out</sub> > 20 % (mm)	TYPICAL OUTPUT CURRENT UNDER TEST <sup>(2)</sup> (mA)	DAYLIGHT BLOCKING FILTER INTEGRATED
CNY70	0	0 to 5	1	Yes

#### Notes

- (1) CTR: current transference ratio,  $I_{out}/I_{in}$   
 (2) Conditions like in table basic characteristics/sensors

### ORDERING INFORMATION

ORDERING CODE	PACKAGING	VOLUME <sup>(1)</sup>	REMARKS
CNY70	Tube	MOQ: 4000 pcs, 80 pcs/tube	-

#### Note

- (1) MOQ: minimum order quantity

### ABSOLUTE MAXIMUM RATINGS (T<sub>amb</sub> = 25 °C, unless otherwise specified)

PARAMETER	TEST CONDITION	SYMBOL	VALUE	UNIT
<b>COUPLER</b>				
Total power dissipation	T <sub>amb</sub> ≤ 25 °C	P <sub>tot</sub>	200	mW
Ambient temperature range		T <sub>amb</sub>	- 40 to + 85	°C
Storage temperature range		T <sub>stg</sub>	- 40 to + 100	°C
Soldering temperature	Distance to case 2 mm, t ≤ 5 s	T <sub>sd</sub>	260	°C
<b>INPUT (EMITTER)</b>				
Reverse voltage		V <sub>R</sub>	5	V
Forward current		I <sub>F</sub>	50	mA
Forward surge current	t <sub>p</sub> ≤ 10 μs	I <sub>FSM</sub>	3	A
Power dissipation	T <sub>amb</sub> ≤ 25 °C	P <sub>V</sub>	100	mW
Junction temperature		T <sub>j</sub>	100	°C



ABSOLUTE MAXIMUM RATINGS ( $T_{amb} = 25\text{ }^{\circ}\text{C}$ , unless otherwise specified)				
PARAMETER	TEST CONDITION	SYMBOL	VALUE	UNIT
<b>OUTPUT (DETECTOR)</b>				
Collector emitter voltage		$V_{CEO}$	32	V
Emitter collector voltage		$V_{ECO}$	7	V
Collector current		$I_C$	50	mA
Power dissipation	$T_{amb} \leq 25\text{ }^{\circ}\text{C}$	$P_V$	100	mW
Junction temperature		$T_j$	100	$^{\circ}\text{C}$

**ABSOLUTE MAXIMUM RATINGS**

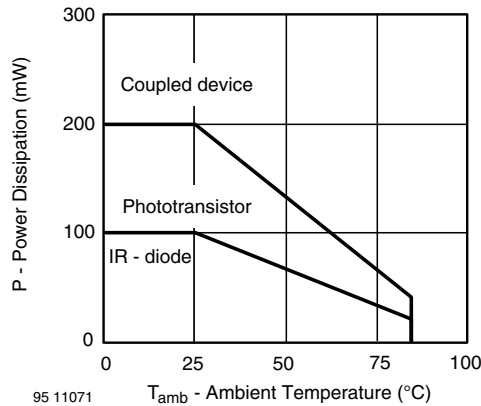

Fig. 1 - Power Dissipation vs. Ambient Temperature

BASIC CHARACTERISTICS ( $T_{amb} = 25\text{ }^{\circ}\text{C}$ , unless otherwise specified)						
PARAMETER	TEST CONDITION	SYMBOL	MIN.	TYP.	MAX.	UNIT
<b>COUPLER</b>						
Collector current	$V_{CE} = 5\text{ V}$ , $I_F = 20\text{ mA}$ , $d = 0.3\text{ mm}$ (figure 1)	$I_C^{(2)}$	0.3	1.0		mA
Cross talk current	$V_{CE} = 5\text{ V}$ , $I_F = 20\text{ mA}$ , (figure 2)	$I_{CX}^{(3)}$			600	nA
Collector emitter saturation voltage	$I_F = 20\text{ mA}$ , $I_C = 0.1\text{ mA}$ , $d = 0.3\text{ mm}$ (figure 1)	$V_{CEsat}^{(2)}$			0.3	V
<b>INPUT (EMITTER)</b>						
Forward voltage	$I_F = 50\text{ mA}$	$V_F$		1.25	1.6	V
Radiant intensity	$I_F = 50\text{ mA}$ , $t_p = 20\text{ ms}$	$I_e$			7.5	mW/sr
Peak wavelength	$I_F = 100\text{ mA}$	$\lambda_P$	940			nm
Virtual source diameter	Method: 63 % encircled energy	$d$		1.2		mm
<b>OUTPUT (DETECTOR)</b>						
Collector emitter voltage	$I_C = 1\text{ mA}$	$V_{CEO}$	32			V
Emitter collector voltage	$I_E = 100\text{ }\mu\text{A}$	$V_{ECO}$	5			V
Collector dark current	$V_{CE} = 20\text{ V}$ , $I_F = 0\text{ A}$ , $E = 0\text{ lx}$	$I_{CEO}$			200	nA

**Notes**

- (1) Measured with the "Kodak neutral test card", white side with 90 % diffuse reflectance
- (2) Measured without reflecting medium

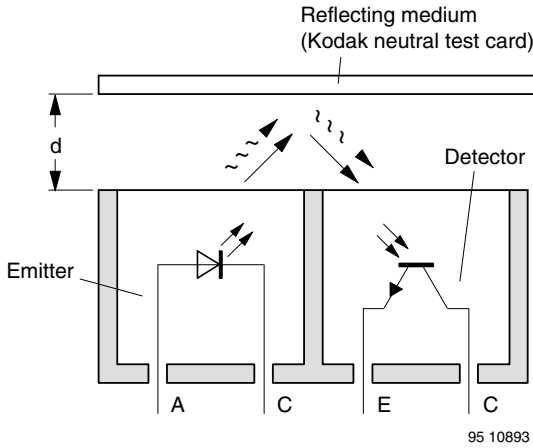

Fig. 2 - Test Condition

**BASIC CHARACTERISTICS** ( $T_{amb} = 25\text{ }^\circ\text{C}$ , unless otherwise specified)

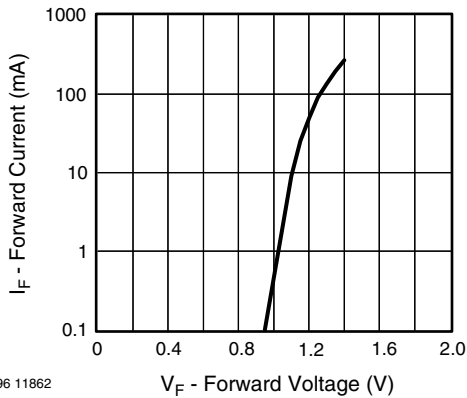

Fig. 3 - Forward Current vs. Forward Voltage

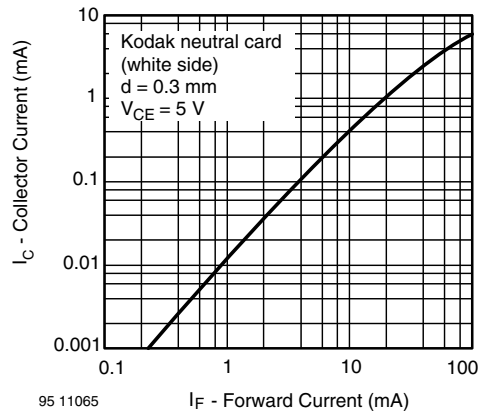

Fig. 5 - Collector Current vs. Forward Current

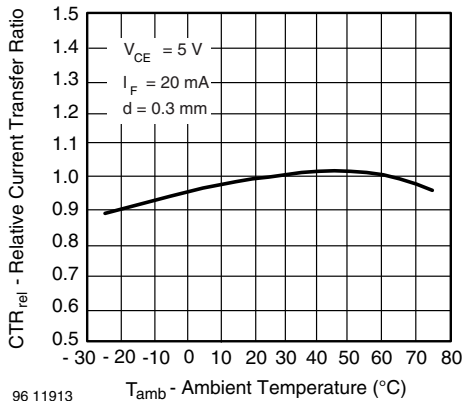

Fig. 4 - Relative Current Transfer Ratio vs. Ambient Temperature

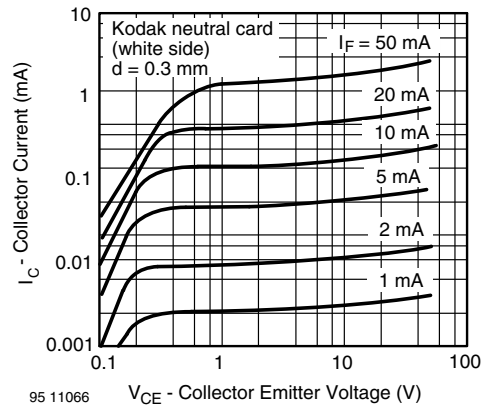

Fig. 6 - Collector Current vs. Collector Emitter Voltage



Fig. 7 - Current Transfer Ratio vs. Forward Current

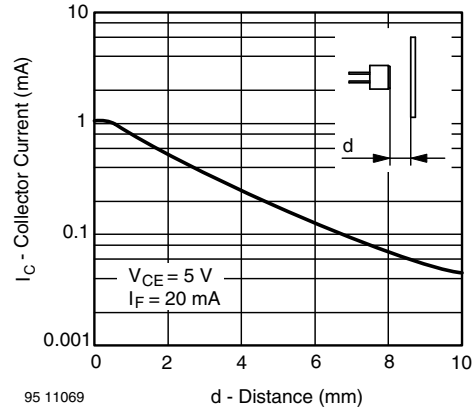

Fig. 9 - Collector Current vs. Distance



Fig. 8 - Current Transfer Ratio vs. Collector Emitter Voltage

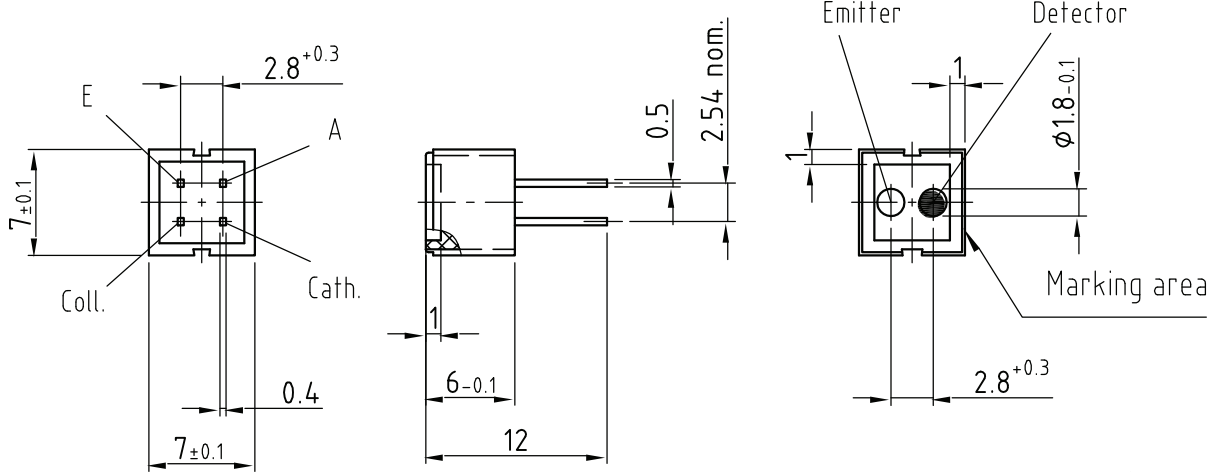

Fig. 10 - Relative Radiant Intensity/Collector Current vs. Angular Displacement

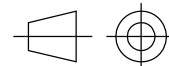

Fig. 11 - Relative Collector Current vs. Displacement

**PACKAGE DIMENSIONS** in millimeters



weight: ca. 0.70g



technical drawings according to DIN specifications

Drawing-No.: 6.544-5062.01-4

Issue: 6; 03.05.06

95 11345

**TUBE DIMENSIONS** in millimeters

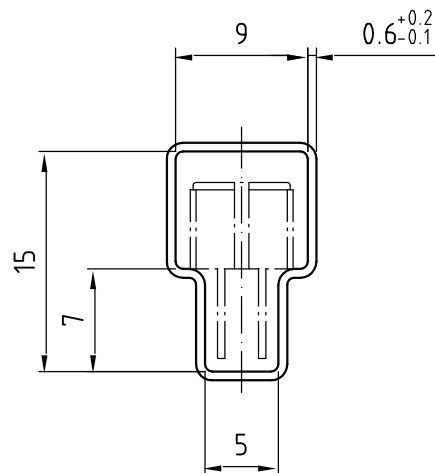

With rubber stopper

Tolerance:  $\pm 0.5$ mm

Length:  $575 \pm 1$ mm

Drawing-No.: 9.700-5097.01-4

Issue: 1; 25.02.00

20291